

**CJ  
EN  
IK  
2023**

# Cjenik 2023

## Pricelist 2023

|                    |                         |
|--------------------|-------------------------|
| Trend              | Operative               |
| Trend Metal        | Operative               |
| Trend Metal Light  | Operative               |
| Elegance Operative | Operative               |
| Elegance Executive | Executive               |
| Infinity Operative | Operative               |
| Infinity Executive | Executive               |
| Tempus             | Executive               |
| <b>Harmony</b>     | <b>Executive</b>        |
| Enter              | Counters                |
| Enter Call Center  | Call Center             |
| Flexy Plus         | Height adjustable desks |
| Clip               | Folding tables          |
| Home Office        | Operative               |
| Eduka              | Chairs                  |
| Stolice            | Chairs                  |
| Dodaci             | Accessories             |

Trend

Elegance

Infinity

Tempus

**Harmony**

Enter

Flexy Plus

Clip

Home Office

Eduka

Stolice

Dodaci

**Velinac**  
ured za Vaš prestiž

Topovi i noge radnih stolova te topovi konferencijskih stolova izrađeni su od iveraladebljine 43 mm. Vezna ploča izrađena je od iverala 36 mm dok je prednja ploča radnih stolova izrađena od iverala 18 mm. Rubovi su kantirani ABS rubnom trakom 1 mm odnosno 2 mm. Radni stolovi opremljeni su dekorativnim odstojnicima. Visina stola može se nivelirati pomoću ugrađenih nožica za nivelaciju.

Work table tops, legs and conference table tops are made of 43 mm refined chipboard. Connecting panel is made of 36 mm refined chipboard while modesty panels are made of 18 mm refined chipboard. Edges are made of 1 mm and 2 mm ABS edging. Work tables are equipped with decorative spacers. Table can be leveled using built-in leveling feet.

---

Potkonstrukcija za konferencijske stolove sastoji se od metalne noge kružnog presjeka promjera 120 mm s postoljem promjera 600 mm, sve lakirano u sivu boju.

Conference table substructure consists of a circular metal column 120mm in diameter and foot plate 600 mm in diameter, all powder coated in grey colour.

---

Bazni elementi izrađeni su od iverala debljine 18 mm rubova kantiranih ABS rubnom trakom 1 mm odnosno 0,5 mm. Radni stolovi, radni stolovi za bazni element te topovi konferencijskih stolova mogu biti izrađeni i u MDF-u lakiranom bijelim lakom visokog sjaja.

Base elements are made of 18 mm refined chipboard with 1 mm and 0.5 mm ABS edging. Work tables and conference table tops can also be made of MDF in glossy white finish.

---

Svi artikli sukladni su odgovarajućim hrvatskim (HRN) i europskim (EN) normama.

Za standardni program roba se isporučuje sa skladišta s vrlo kratkim rokovima isporuke. Dostava i montaža su osigurane.

Odobravamo značajne rabate, ovisno o vrijednosti kupljene robe. Za plaćanje po predračunu odobravamo kasaskonto.

Garancija 5 godina. Omogućujemo oblik financiranja putem operativnog najma na period od 12-60 mjeseci.

All items have the appropriate certificate under the ordinance of mandatory testing of furniture. Standard products are shipped from the warehouse with very short delivery time. Delivery and installation are provided. Warranty is 5 years. We grant substantial rebates depending on the value of purchased products. For advance payments we allow additional discount.

Dekor standard (STAND.) / Decor standard (STAND.)

Top  
Struktura  
Bazni element



Tabletop  
Structure  
Base element

Tamni hrast  
Dark oak

Dekor plus (PLUS) / Decor plus (PLUS)

Top  
Struktura  
Bazni element



Tabletop  
Structure  
Base element

Bijeli hrast  
White oak

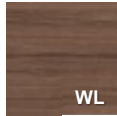

Orah  
Walnut

Bazni element

Base element



Kamen sivi  
Stone grey

Dekor sjaj (GLOSS) / Decor gloss (GLOSS)

Bazni element

Base element



Bijelo sjaj  
Glossy white

Dekor MDF / Decor MDF

Top  
Struktura

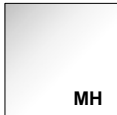

Tabletop  
Structure

MDF lak bijelo sjaj  
White high gloss lacquered

Metalna struktura za radni stol / Metal structure for work table

Metalna struktura

Metal structure



Siva  
Grey

Ručkice / Handles



Metal chrom  
Metal chrom

Pravokutni radni stol / Rectangular work table

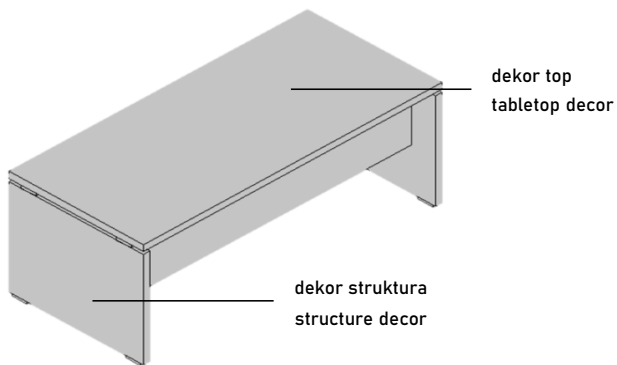

Primjer narudžbe:  
Order example:

ART. **MO 50015**

artikl  
article

dekor top i struktura  
tabletop and structure decor

Pravokutni radni stol za bazni element / Rectangular work table for base element

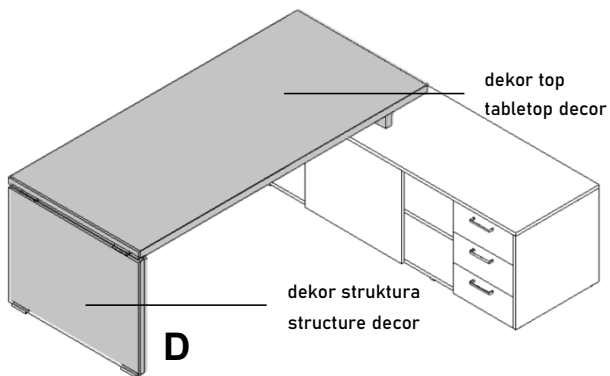

D - bazni element na desnoj strani  
D - base element on the right side

Primjer narudžbe:  
Order example:

ART. **MO 50020 D**

artikl  
article

dekor top i struktura  
tabletop and structure decor

Bazni element / Base element

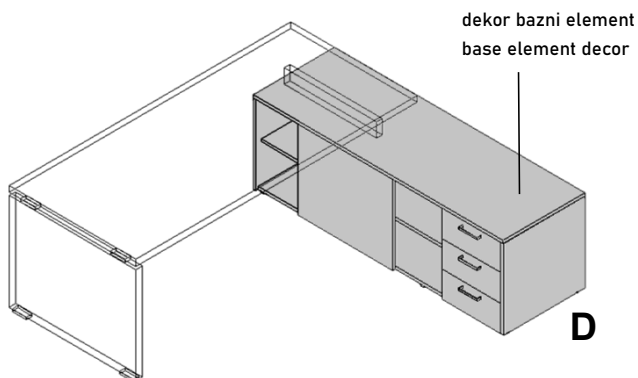

D - desni bazni element  
D - the right base element

Primjer narudžbe:  
Order example:

ART. **MO 50022 D**

artikl  
article

dekor bazni element  
base element decor

## Pravokutni radni stol / Rectangular work table

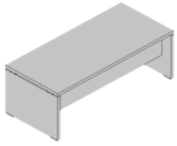

| Art.  | W   | D  | H    | STAND. Kn   | STAND. €    | PLUS Kn     | PLUS €      | MDF Kn      | MDF €       |
|-------|-----|----|------|-------------|-------------|-------------|-------------|-------------|-------------|
|       |     |    |      | VPC / PRICE | VPC / PRICE | VPC / PRICE | VPC / PRICE | VPC / PRICE | VPC / PRICE |
| 50015 | 180 | 90 | 75,8 | 2.347,00    | 311,50      | 3.951,02    | 524,39      | 6.827,91    | 906,22      |
| 50016 | 200 | 90 | 75,8 | 2.442,99    | 324,24      | 4.161,00    | 552,26      | 7.298,97    | 968,74      |

## Pravokutni radni stol za bazni element / Rectangular work table for base element

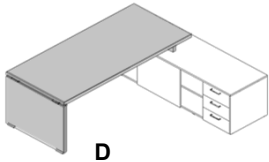

| Art.    | W   | D  | H    | STAND. Kn   | STAND. €    | PLUS Kn     | PLUS €      | MDF Kn      | MDF €       |
|---------|-----|----|------|-------------|-------------|-------------|-------------|-------------|-------------|
|         |     |    |      | VPC / PRICE | VPC / PRICE | VPC / PRICE | VPC / PRICE | VPC / PRICE | VPC / PRICE |
| 50020 L | 200 | 90 | 75,8 | 2.199,02    | 291,86      | 3.327,01    | 441,57      | 4.791,04    | 635,88      |
| 50020 D | 220 | 90 | 75,8 | 2.199,02    | 291,86      | 3.327,01    | 441,57      | 4.791,04    | 635,88      |
| 50021 L | 200 | 90 | 75,8 | 2.249,95    | 298,62      | 3.528,03    | 468,25      | 5.117,06    | 679,15      |
| 50021 D | 220 | 90 | 75,8 | 2.249,95    | 298,62      | 3.528,03    | 468,25      | 5.117,06    | 679,15      |

## Bazni element / Base element

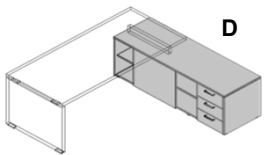

| Art.    | W   | D  | H    | STAND. Kn   | STAND. €    | PLUS Kn     | PLUS €      | GLOSS Kn    | GLOSS €     |
|---------|-----|----|------|-------------|-------------|-------------|-------------|-------------|-------------|
|         |     |    |      | VPC / PRICE | VPC / PRICE | VPC / PRICE | VPC / PRICE | VPC / PRICE | VPC / PRICE |
| 50022 L | 178 | 58 | 59,5 | 3.746,98    | 497,31      | 5.045,03    | 669,59      | 5.316,04    | 705,56      |
| 50022 D | 178 | 58 | 59,5 | 3.746,98    | 497,31      | 5.045,03    | 669,59      | 5.316,04    | 705,56      |

## Bazni element / Base element

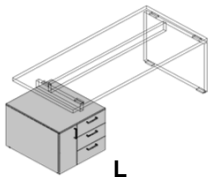

| Art.    | W  | D  | H    | STAND. Kn   | STAND. €    | PLUS Kn     | PLUS €      | GLOSS Kn    | GLOSS €     |
|---------|----|----|------|-------------|-------------|-------------|-------------|-------------|-------------|
|         |    |    |      | VPC / PRICE | VPC / PRICE | VPC / PRICE | VPC / PRICE | VPC / PRICE | VPC / PRICE |
| 50023 L | 68 | 80 | 59,5 | 2.563,01    | 340,17      | 3.392,03    | 450,20      | 3.744,04    | 496,92      |
| 50023 D | 68 | 80 | 59,5 | 2.563,01    | 340,17      | 3.392,03    | 450,20      | 3.744,04    | 496,92      |

## Okrugli konferencijski stol / Round conference table



| Art.  | W    | D | H    | STAND. Kn   | STAND. €    | PLUS Kn     | PLUS €      | MDF Kn      | MDF €       |
|-------|------|---|------|-------------|-------------|-------------|-------------|-------------|-------------|
|       |      |   |      | VPC / PRICE | VPC / PRICE | VPC / PRICE | VPC / PRICE | VPC / PRICE | VPC / PRICE |
| 50100 | Ø120 |   | 75,8 | 2.562,03    | 340,04      | 2.957,07    | 392,47      | 3.971,06    | 527,05      |

## Pravokutni konferencijski stol / Rectangular conference table

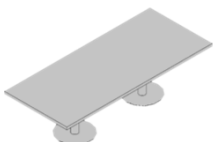

| Art.  | W   | D   | H    | STAND. Kn   | STAND. €    | PLUS Kn     | PLUS €      | MDF Kn      | MDF €       |
|-------|-----|-----|------|-------------|-------------|-------------|-------------|-------------|-------------|
|       |     |     |      | VPC / PRICE | VPC / PRICE | VPC / PRICE | VPC / PRICE | VPC / PRICE | VPC / PRICE |
| 50103 | 220 | 120 | 75,8 | 4.957,10    | 657,92      | 5.822,06    | 772,72      | 7.579,03    | 1.005,91    |
| 50104 | 280 | 120 | 75,8 | 5.302,10    | 703,71      | 6.109,05    | 810,81      | 8.666,03    | 1.150,18    |

## Prednja ploča za radni stol za bazni element / Frontal panel for work table for base element

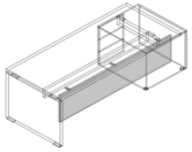

| Art.         | W   | D   | H  | STAND. Kn     | STAND. €     | PLUS Kn       | PLUS €       | MDF Kn          | MDF €         |
|--------------|-----|-----|----|---------------|--------------|---------------|--------------|-----------------|---------------|
|              |     |     |    | VPC / PRICE   | VPC / PRICE  | VPC / PRICE   | VPC / PRICE  | VPC / PRICE     | VPC / PRICE   |
| <b>50126</b> | 184 | 1,8 | 40 | <b>425,10</b> | <b>56,42</b> | <b>580,08</b> | <b>76,99</b> | <b>1.285,08</b> | <b>170,56</b> |
| <b>50127</b> | 204 | 1,8 | 40 | <b>449,06</b> | <b>59,60</b> | <b>625,06</b> | <b>82,96</b> | <b>1.421,08</b> | <b>188,61</b> |

Korpusi kazeta, stropovi i fronte izrađeni su od iverala debljine 18 mm. Kod fiksnih kazeta stropovi prate debljinu topa radnog stola. Leđa kazeta izrađena su od iverala debljine 18 mm. Ladice su izrađene od iverala 12 mm s podnicom od 4 mm u lakiranom Mdf-u ili su metalne. Kazete su opremljene bravicom za centralno zaključavanje, te imaju ugrađen „soft closing“ sistem. Kazete s metalnim ladicama imaju ugrađen i sistem osiguranja protiv prevrtanja. Pokretne kazete su opremljene kotačima.

Chest of drawers body, top and front are made of 18 mm thick refined chipboard. The top of fixed chest of drawers is in line with the work table top thickness. The chest of drawers back is made of 18 mm thick refined chipboard. The drawers are made of 12 mm thick refined chipboard with 4 mm thick drawer bottom in lacquered Mdf or metal drawers. The chest of drawers is equipped with a lock for simultaneous locking of all drawers and a soft closing system. Metallic chest of drawers has built-in anti-roll-over system. Movable chest of drawers is on wheels.

---

Svi artikli sukladni su odgovarajućim hrvatskim (HRN) i europskim (EN) normama.

Za standardni program roba se isporučuje sa skladišta s vrlo kratkim rokovima isporuke. Dostava i montaža su osigurane.

Odobravamo značajne rabate, ovisno o vrijednosti kupljene robe. Za plaćanje po predračunu odobravamo kasaskonto.

Garancija 5 godina. Omogućujemo oblik financiranja putem operativnog najma na period od 12-60 mjeseci.

All items have the appropriate certificate under the ordinance of mandatory testing of furniture. Standard products are shipped from the warehouse with very short delivery time. Delivery and installation are provided. Warranty is 5 years. We grant substantial rebates depending on the value of purchased products. For advance payments we allow additional discount.



## Dekor standard (STAND.) / Decor standard (STAND.)

Top  
Fronte  
Struktura

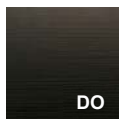

Finishing top  
Fronts  
Structure

Tamni hrast  
Dark oak

## Dekor plus (PLUS) / Decor plus (PLUS)

Top  
Fronte  
Struktura



Finishing top  
Fronts  
Structure

Bijeli hrast  
White oak

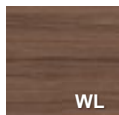

Orah  
Walnut



Kamen sivi  
Stone grey

## Dekor sjaj (GLOSS) / Decor gloss (GLOSS)

Top  
Fronte  
Struktura



Finishing top  
Fronts  
Structure

Bijelo sjaj  
Glossy white

## Ručkice / Handles



Metal chrom  
Metal chrom

Pokretna kazeta s 3 metalne ladice / Mobile drawer unit with 3 metal drawers

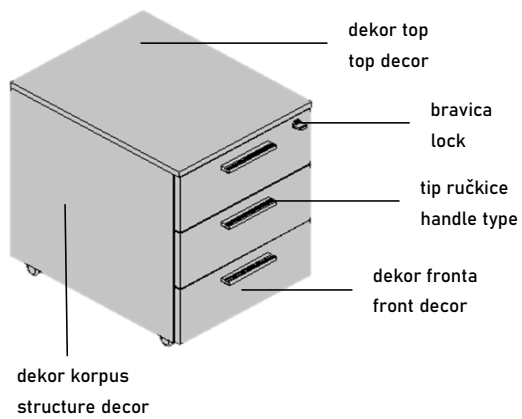

Primjer narudžbe:  
Order example:

ART. **DO 60322 - RMC**

tip ručkice  
handle type

artikl  
article

dekor top, fronta i korpus  
top, front and structure decor

## Pokretna kazeta s 3 metalne ladice / Mobile drawer unit with 3 metal drawers



| Art.         | W  | D  | H  | STAND. Kn       | STAND. €      | PLUS Kn         | PLUS €        | GLOSS Kn        | GLOSS €       |
|--------------|----|----|----|-----------------|---------------|-----------------|---------------|-----------------|---------------|
|              |    |    |    | VPC / PRICE     | VPC / PRICE   | VPC / PRICE     | VPC / PRICE   | VPC / PRICE     | VPC / PRICE   |
| <b>60322</b> | 42 | 56 | 55 | <b>2.045,99</b> | <b>271,55</b> | <b>1.876,99</b> | <b>249,12</b> | <b>2.013,97</b> | <b>267,30</b> |

## Pokretna kazeta s 4 metalne ladice / Mobile drawer unit with 4 metal drawers



| Art.         | W  | D  | H  | STAND. Kn       | STAND. €      | PLUS Kn         | PLUS €        | GLOSS Kn        | GLOSS €       |
|--------------|----|----|----|-----------------|---------------|-----------------|---------------|-----------------|---------------|
|              |    |    |    | VPC / PRICE     | VPC / PRICE   | VPC / PRICE     | VPC / PRICE   | VPC / PRICE     | VPC / PRICE   |
| <b>60324</b> | 42 | 56 | 64 | <b>1.997,02</b> | <b>265,05</b> | <b>2.468,00</b> | <b>327,56</b> | <b>2.637,98</b> | <b>350,12</b> |

## Mobilni element / Mobile element



D

| Art.           | W    | D  | H  | STAND. Kn       | STAND. €      | PLUS Kn         | PLUS €        | GLOSS Kn        | GLOSS €       |
|----------------|------|----|----|-----------------|---------------|-----------------|---------------|-----------------|---------------|
|                |      |    |    | VPC / PRICE     | VPC / PRICE   | VPC / PRICE     | VPC / PRICE   | VPC / PRICE     | VPC / PRICE   |
| <b>60312 L</b> | 89,6 | 58 | 58 | <b>1.855,97</b> | <b>246,33</b> | <b>2.336,00</b> | <b>310,04</b> | <b>2.973,04</b> | <b>394,59</b> |
| <b>60312 D</b> | 89,6 | 58 | 58 | <b>1.855,97</b> | <b>246,33</b> | <b>2.336,00</b> | <b>310,04</b> | <b>2.973,04</b> | <b>394,59</b> |

Korpusi ormara i fronte izrađeni su od iverala debljine 18 mm. Police su izrađene od iverala debljine 25mm, ukrasni topovi i ukrasne stranice od iverala 25 mm odnosno 18 mm. Leđa ormara izrađena su od iverala debljine 18 mm, te se s korpusom ormara spajaju "klik" sistemom okova. Svi rubovi ormara kantirani su ABS rubnom trakom.

Body cabinet and front are made of 18 mm thick refined chipboard. Shelves are made of 25 mm refined chipboard, decorative tops and decorative side panels are made of 25 mm or 18 mm refined chipboard. The back of the cabinet is made of 18 mm thick refined chipboard and it is connected to the cabinet body by a "click" system. ABS edging is applied all around the cabinet edges.

---

Ormari su opremljeni nožicama za regulaciju visine i po potrebi bravicama. Staklena vrata ormara izrađena su od stakla debljine 5 mm odnosno satiniranog ili lacobel stakla u aluminijskom okviru. Ormari s drvenim vratima imaju ugrađene ublaživače udarca.

The cabinet comes equipped with built-in levelling foot for height adjustment and as needed cabinet lock. Glass cabinet doors are made of 5 mm thick or satin or lacobel glass in aluminium frame. Wooden door cabinets have built-in shock absorbers.

---

Svi artikli sukladni su odgovarajućim hrvatskim (HRN) i europskim (EN) normama.

Za standardni program roba se isporučuje sa skladišta s vrlo kratkim rokovima isporuke. Dostava i montaža su osigurane.

Odobravamo značajne rabate, ovisno o vrijednosti kupljene robe. Za plaćanje po predračunu odobravamo kasaskonto.

Garancija 5 godina. Omogućujemo oblik financiranja putem operativnog najma na period od 12-60 mjeseci.

All items have the appropriate certificate under the ordinance of mandatory testing of furniture. Standard products are shipped from the warehouse with very short delivery time. Delivery and installation are provided. Warranty is 5 years. We grant substantial rebates depending on the value of purchased products. For advance payments we allow additional discount.



## Dekor korpus / Decor structure

|                     |                                                                                                   |                                                                                                             |
|---------------------|---------------------------------------------------------------------------------------------------|-------------------------------------------------------------------------------------------------------------|
| Korpus<br>Structure | <br>Siva<br>Grey | <br>Antracit<br>Anthracite |
|---------------------|---------------------------------------------------------------------------------------------------|-------------------------------------------------------------------------------------------------------------|

## Dekor standard (STAND.) / Decor standard (STAND.)

|                                            |                                                                                         |
|--------------------------------------------|-----------------------------------------------------------------------------------------|
| Fronte<br>Ukrasni top<br>Ukrasne stranice  | <br>DO |
| Fronts<br>Finishing top<br>Finishing sides | Tamni hrast<br>Dark oak                                                                 |

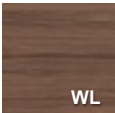
## Dekor plus (PLUS) / Decor plus (PLUS)

|                                            |                                                                                          |                                                                                          |                                                                                          |
|--------------------------------------------|------------------------------------------------------------------------------------------|------------------------------------------------------------------------------------------|------------------------------------------------------------------------------------------|
| Fronte<br>Ukrasni top<br>Ukrasne stranice  | <br>MO | <br>WL | <br>RG |
| Fronts<br>Finishing top<br>Finishing sides | Bijeli hrast<br>White oak                                                                | Orah<br>Walnut                                                                           | Kamen sivi<br>Stone grey                                                                 |

## Dekor sjaj (GLOSS) / Decor gloss (GLOSS)

|                                            |                                                                                           |
|--------------------------------------------|-------------------------------------------------------------------------------------------|
| Fronte<br>Ukrasni top<br>Ukrasne stranice  | <br>WG |
| Fronts<br>Finishing top<br>Finishing sides | Bijelo sjaj<br>Glossy white                                                               |

## Staklo u aluminijskom okviru / Aluminium framed glass doors

|        |                                                                                             |                                                                                             |
|--------|---------------------------------------------------------------------------------------------|---------------------------------------------------------------------------------------------|
| Fronte | <br>AL/S | <br>AL/W |
| Fronts | Satinirano staklo<br>Satin glass                                                            | Lacobel bijeli<br>Lacobel white                                                             |

## Ručkice / Handles



Metal chrom  
Metal chrom

## Ormar s punim vratima / Cabinet with solid doors

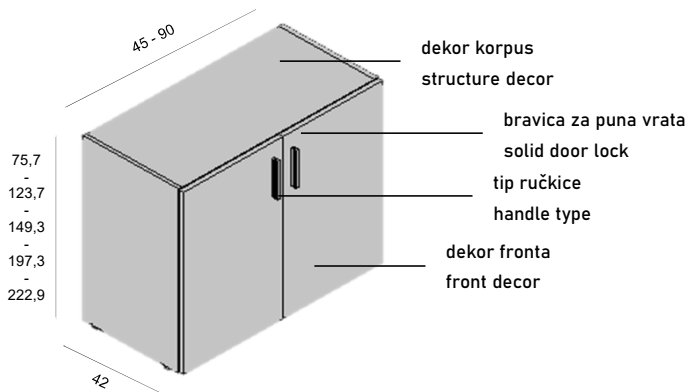

Primjer narudžbe:  
Order example:

ART. **LO 66002 G B - RMC**

|                             |                   |                                 |                                          |
|-----------------------------|-------------------|---------------------------------|------------------------------------------|
| dekor fronta<br>front decor | artikl<br>article | dekor korpus<br>structure decor | tip ručkice<br>handle type               |
|                             |                   |                                 | bravica za puna vrata<br>solid door lock |

NAPOMENA: Obavezno odabrati odgovarajući ukrasni top (za jedan ili više ormara u nizu). Odabir ukrasnih stranica po želji.  
NOTE: Be sure to choose the right finishing top (for one or more cabinets in line). Finishing sides optional.

## Ormar sa staklenim vratima u aluminijskom okviru / Cabinet with aluminium framed glass doors

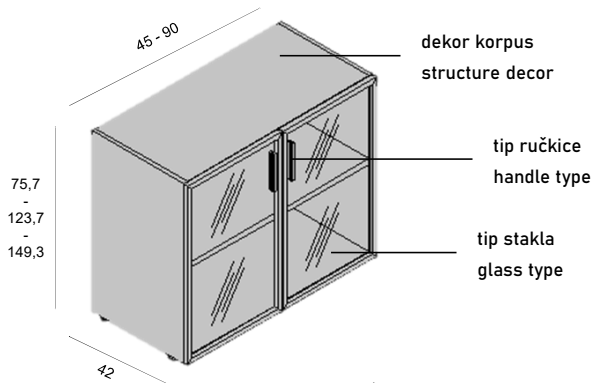

Primjer narudžbe:  
Order example:

ART. **66004 G AL/S - RMC**

|                   |                                 |                            |
|-------------------|---------------------------------|----------------------------|
| artikl<br>article | dekor korpus<br>structure decor | tip ručkice<br>handle type |
|                   |                                 | tip stakla<br>glass type   |

\*Nije moguć odabir bravice za staklena vrata aluminijskom okviru  
\*No lock possible for aluminium framed glass doors

NAPOMENA: Obavezno odabrati odgovarajući ukrasni top (za jedan ili više ormara u nizu). Odabir ukrasnih stranica po želji.  
NOTE: Be sure to choose the right finishing top (for one or more cabinets in line). Finishing sides optional.

## Ormar puna vrata + staklena vrata u aluminijskom okviru / Cabinet solid doors + aluminium framed glass doors

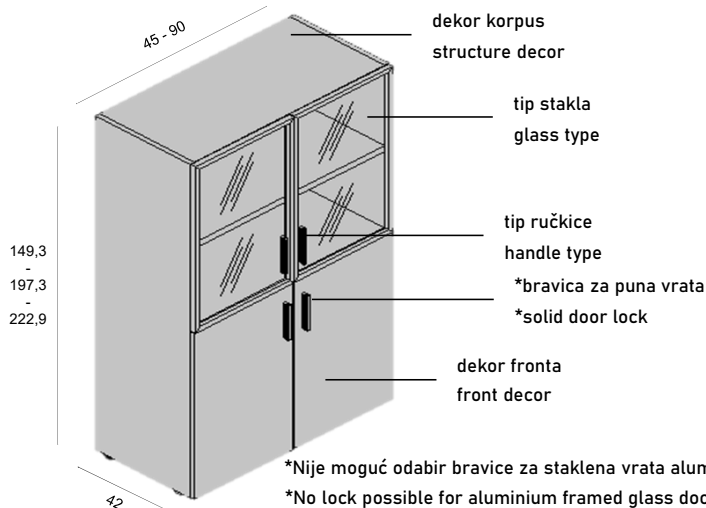

Primjer narudžbe:  
Order example:

ART. **LO 66038 G AL/S B - RMC**

|                             |                   |                                 |                                          |
|-----------------------------|-------------------|---------------------------------|------------------------------------------|
| dekor fronta<br>front decor | artikl<br>article | dekor korpus<br>structure decor | tip ručkice<br>handle type               |
|                             |                   |                                 | bravica za puna vrata<br>solid door lock |
|                             |                   |                                 | tip stakla<br>glass type                 |

\*Nije moguć odabir bravice za staklena vrata aluminijskom okviru  
\*No lock possible for aluminium framed glass doors

NAPOMENA: Obavezno odabrati odgovarajući ukrasni top (za jedan ili više ormara u nizu). Odabir ukrasnih stranica po želji.  
NOTE: Be sure to choose the right finishing top (for one or more cabinets in line). Finishing sides optional.

Ukrasni top za ormar s ukrasnim stranicama - deb. 18 mm / Finishing top for cabinet with finishing sides - thick. 18 mm

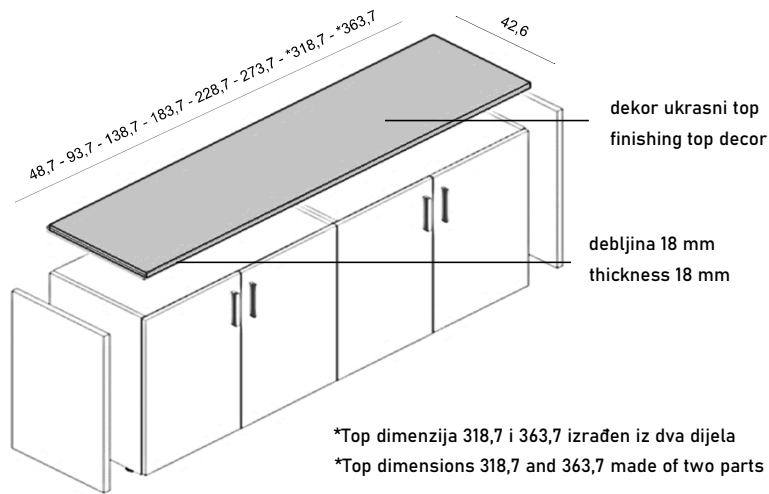

Primjer narudžbe:  
Order example:

ART. **DO 66071**

artikl  
article

dekor ukrasni top  
finishing top decor

Ukrasne stranice za ormar - deb. 18 mm / Finishing sides for cabinet - thick. 18 mm

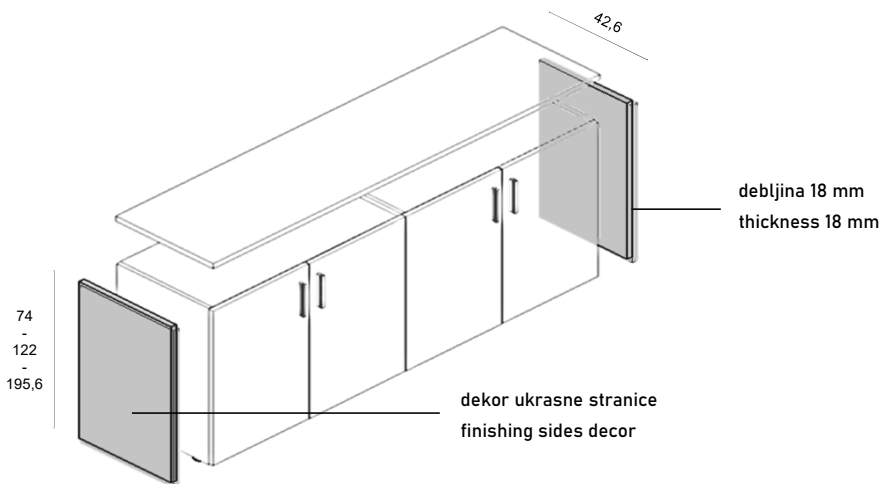

Primjer narudžbe:  
Order example:

ART. **DO 66081**

artikl  
article

dekor ukrasne stranice  
finishing sides decor

Dodatne police / Additional shelves

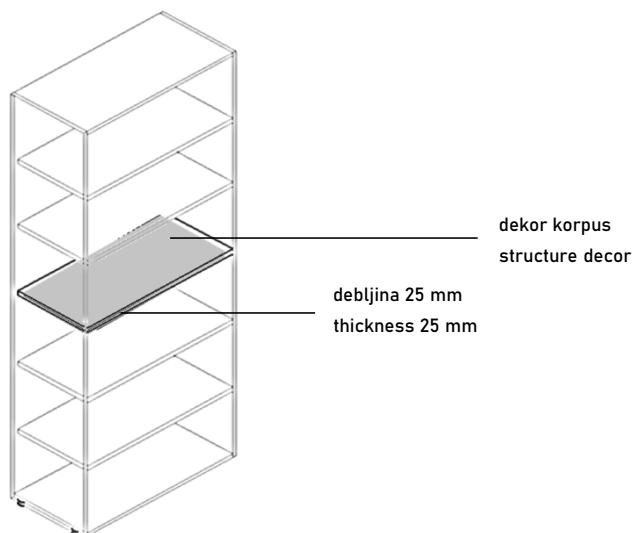

Primjer narudžbe:  
Order example:

ART. **65099 G**

artikl  
article

dekor korpus  
structure decor

## Ormar s punim vratima - visine 75,7 cm / Cabinet with solid doors - height 75,7 cm

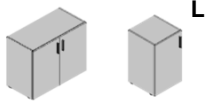

| Art.           | W  | D  | H    | STAND. Kn       | STAND. €      | PLUS Kn         | PLUS €        | GLOSS Kn        | GLOSS €       |
|----------------|----|----|------|-----------------|---------------|-----------------|---------------|-----------------|---------------|
|                |    |    |      | VPC / PRICE     | VPC / PRICE   | VPC / PRICE     | VPC / PRICE   | VPC / PRICE     | VPC / PRICE   |
| <b>66002</b>   | 90 | 42 | 75,7 | <b>1.314,02</b> | <b>174,40</b> | <b>1.411,06</b> | <b>187,28</b> | <b>1.453,03</b> | <b>192,85</b> |
| <b>66102 L</b> | 45 | 42 | 75,7 | <b>817,04</b>   | <b>108,44</b> | <b>906,02</b>   | <b>120,25</b> | <b>947,99</b>   | <b>125,82</b> |
| <b>66102 D</b> | 45 | 42 | 75,7 | <b>817,04</b>   | <b>108,44</b> | <b>906,02</b>   | <b>120,25</b> | <b>947,99</b>   | <b>125,82</b> |

## Ormar s punim vratima - visine 123,7 cm / Cabinet with solid doors - height 123,7 cm

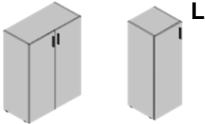

| Art.           | W  | D  | H     | STAND. Kn       | STAND. €      | PLUS Kn         | PLUS €        | GLOSS Kn        | GLOSS €       |
|----------------|----|----|-------|-----------------|---------------|-----------------|---------------|-----------------|---------------|
|                |    |    |       | VPC / PRICE     | VPC / PRICE   | VPC / PRICE     | VPC / PRICE   | VPC / PRICE     | VPC / PRICE   |
| <b>66012</b>   | 90 | 42 | 123,7 | <b>1.847,01</b> | <b>245,14</b> | <b>2.008,02</b> | <b>266,51</b> | <b>2.116,97</b> | <b>280,97</b> |
| <b>66112 L</b> | 45 | 42 | 123,7 | <b>1.123,02</b> | <b>149,05</b> | <b>1.217,05</b> | <b>161,53</b> | <b>1.276,04</b> | <b>169,36</b> |
| <b>66112 D</b> | 45 | 42 | 123,7 | <b>1.123,02</b> | <b>149,05</b> | <b>1.217,05</b> | <b>161,53</b> | <b>1.276,04</b> | <b>169,36</b> |

## Ormar s punim vratima - visine 197,3 cm / Cabinet with solid doors - height 197,3 cm

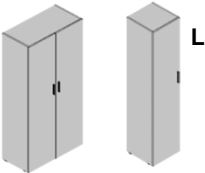

| Art.           | W  | D  | H     | STAND. Kn       | STAND. €      | PLUS Kn         | PLUS €        | GLOSS Kn        | GLOSS €       |
|----------------|----|----|-------|-----------------|---------------|-----------------|---------------|-----------------|---------------|
|                |    |    |       | VPC / PRICE     | VPC / PRICE   | VPC / PRICE     | VPC / PRICE   | VPC / PRICE     | VPC / PRICE   |
| <b>66032</b>   | 90 | 42 | 197,3 | <b>2.831,99</b> | <b>375,87</b> | <b>3.092,99</b> | <b>410,51</b> | <b>3.284,97</b> | <b>435,99</b> |
| <b>66132 L</b> | 45 | 42 | 197,3 | <b>1.758,02</b> | <b>233,33</b> | <b>1.895,00</b> | <b>251,51</b> | <b>1.993,03</b> | <b>264,52</b> |
| <b>66132 D</b> | 45 | 42 | 197,3 | <b>1.758,02</b> | <b>233,33</b> | <b>1.895,00</b> | <b>251,51</b> | <b>1.993,03</b> | <b>264,52</b> |

## Ormar s niskim i srednjim punim vratima - visine 197,3 cm / Cabinet with low and middle solid doors - height 197,3 cm

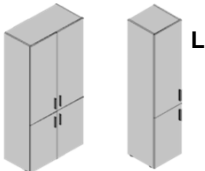

| Art.           | W  | D  | H     | STAND. Kn       | STAND. €      | PLUS Kn         | PLUS €        | GLOSS Kn        | GLOSS €       |
|----------------|----|----|-------|-----------------|---------------|-----------------|---------------|-----------------|---------------|
|                |    |    |       | VPC / PRICE     | VPC / PRICE   | VPC / PRICE     | VPC / PRICE   | VPC / PRICE     | VPC / PRICE   |
| <b>66036</b>   | 90 | 42 | 197,3 | <b>2.975,00</b> | <b>394,85</b> | <b>3.233,05</b> | <b>429,10</b> | <b>3.383,97</b> | <b>449,13</b> |
| <b>66136 L</b> | 45 | 42 | 197,3 | <b>1.829,00</b> | <b>242,75</b> | <b>2.012,01</b> | <b>267,04</b> | <b>2.112,98</b> | <b>280,44</b> |
| <b>66136 D</b> | 45 | 42 | 197,3 | <b>1.829,00</b> | <b>242,75</b> | <b>2.012,01</b> | <b>267,04</b> | <b>2.112,98</b> | <b>280,44</b> |

## Garderobni ormar s punim vratima - visine 197,3 cm / Wardrobe with solid doors - height 197,3 cm

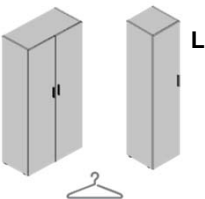

| Art.                | W  | D  | H     | STAND. Kn       | STAND. €      | PLUS Kn         | PLUS €        | GLOSS Kn        | GLOSS €       |
|---------------------|----|----|-------|-----------------|---------------|-----------------|---------------|-----------------|---------------|
|                     |    |    |       | VPC / PRICE     | VPC / PRICE   | VPC / PRICE     | VPC / PRICE   | VPC / PRICE     | VPC / PRICE   |
| <b>66039 GARD</b>   | 90 | 42 | 197,3 | <b>2.637,98</b> | <b>350,12</b> | <b>2.898,97</b> | <b>384,76</b> | <b>3.090,95</b> | <b>410,24</b> |
| <b>66139 GARD L</b> | 45 | 42 | 197,3 | <b>1.674,02</b> | <b>222,18</b> | <b>1.810,99</b> | <b>240,36</b> | <b>1.909,02</b> | <b>253,37</b> |
| <b>66139 GARD D</b> | 45 | 42 | 197,3 | <b>1.674,02</b> | <b>222,18</b> | <b>1.810,99</b> | <b>240,36</b> | <b>1.909,02</b> | <b>253,37</b> |

## Opcije uz nadoplatu / Options at extra charge

Bravica / Lock



Bravica za puna vrata

Solid doors lock

+ 83,03 kn/kom

+ 11,02 €/pcs

NAPOMENA: Obavezno odabrati odgovarajući ukrasni top (za jedan ili više ormara u nizu). Odabir ukrasnih stranica po želji.  
NOTE: Be sure to choose the right finishing top (for one or more cabinets in line). Finishing sides optional.

Cijene su navedene bez PDV-a na dan 10.07.2023 / Prices are excluding VAT on 10.07.2023



Ormar sa staklenim vratima u aluminijском okviru - visine 75,7 cm / Cabinet with aluminium framed glass doors - height 75,7 cm

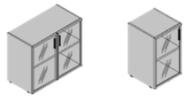

L

| Art.         | W  | D  | H    | G/A Kn      |             | G/A €       |             |
|--------------|----|----|------|-------------|-------------|-------------|-------------|
|              |    |    |      | VPC / PRICE | VPC / PRICE | VPC / PRICE | VPC / PRICE |
| 66004 AL/S   | 90 | 42 | 75,7 | 2.550,96    | 338,57      | 2.550,96    | 338,57      |
| 66104 L AL/S | 45 | 42 | 75,7 | 1.267,98    | 168,29      | 1.267,98    | 168,29      |
| 66104 D AL/S | 45 | 42 | 75,7 | 1.267,98    | 168,29      | 1.267,98    | 168,29      |

Ormar sa staklenim vratima u aluminijском okviru - visine 123,7 cm / Cabinet with aluminium framed glass doors - height 123,7 cm

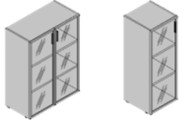

L

| Art.         | W  | D  | H     | G/A Kn      |             | G/A €       |             |
|--------------|----|----|-------|-------------|-------------|-------------|-------------|
|              |    |    |       | VPC / PRICE | VPC / PRICE | VPC / PRICE | VPC / PRICE |
| 66014 AL/S   | 90 | 42 | 123,7 | 2.999,26    | 398,07      | 2.999,26    | 398,07      |
| 66114 L AL/S | 45 | 42 | 123,7 | 1.705,43    | 226,35      | 1.705,43    | 226,35      |
| 66114 D AL/S | 45 | 42 | 123,7 | 1.705,43    | 226,35      | 1.705,43    | 226,35      |

## Opcije uz nadoplatu / Options at extra charge

Staklo u aluminijском okviru / Aluminium framed glass doors



Satinirano staklo

Satin glass

U cijeni

In price



Lacobel bijeli

Lacobel white

Cijena na upit

Price on request

Ormar puna vrata + staklena vrata u alu. okviru - visine 197,3 cm / Cabinet solid doors + aluminium framed glass doors - height 197,3 cm

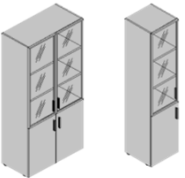

L

| Art.    | W  | D  | H     | STAND. Kn   | STAND. €    | PLUS Kn     | PLUS €      | GLOSS Kn    | GLOSS €     |
|---------|----|----|-------|-------------|-------------|-------------|-------------|-------------|-------------|
|         |    |    |       | VPC / PRICE | VPC / PRICE | VPC / PRICE | VPC / PRICE | VPC / PRICE | VPC / PRICE |
| 66038   | 90 | 42 | 197,3 | 4.127,25    | 547,78      | 4.224,29    | 560,66      | 4.266,26    | 566,23      |
| 66138 L | 45 | 42 | 197,3 | 2.411,42    | 320,05      | 2.500,40    | 331,86      | 2.542,37    | 337,43      |
| 66138 D | 45 | 42 | 197,3 | 2.411,42    | 320,05      | 2.500,40    | 331,86      | 2.542,37    | 337,43      |

## Opcije uz nadoplatu / Options at extra charge

Bravica / Lock



Bravica za puna vrata

Solid doors lock

+ 83,03 kn/kom

+ 11,02 €/pcs

Staklo u aluminijском okviru / Aluminium framed glass doors



Satinirano staklo

Satin glass

U cijeni

In price



Lacobel bijeli

Lacobel white

Cijena na upit

Price on request

NAPOMENA: Obavezno odabrati odgovarajući ukrasni top (za jedan ili više ormara u nizu). Odabir ukrasnih stranica po želji.  
NOTE: Be sure to choose the right finishing top (for one or more cabinets in line). Finishing sides optional.

Cijene su navedene bez PDV-a na dan 10.07.2023 / Prices are excluding VAT on 10.07.2023

## Ukrasni top za ormar s ukrasnim stranicama - deb. 18 mm / Finishing top for cabinet with finishing sides - thick. 18 mm

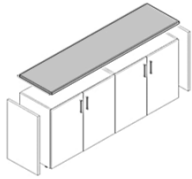

| Art.  | W     | D    | H   | STAND. Kn     | STAND. €     | PLUS Kn       | PLUS €       | GLOSS Kn      | GLOSS €      |
|-------|-------|------|-----|---------------|--------------|---------------|--------------|---------------|--------------|
|       |       |      |     | VPC / PRICE   | VPC / PRICE  | VPC / PRICE   | VPC / PRICE  | VPC / PRICE   | VPC / PRICE  |
| 66071 | 48,7  | 42,6 | 1,8 | <b>66,98</b>  | <b>8,89</b>  | <b>129,97</b> | <b>17,25</b> | <b>150,99</b> | <b>20,04</b> |
| 66072 | 93,7  | 42,6 | 1,8 | <b>111,96</b> | <b>14,86</b> | <b>220,99</b> | <b>29,33</b> | <b>272,00</b> | <b>36,10</b> |
| 66073 | 138,7 | 42,6 | 1,8 | <b>172,01</b> | <b>22,83</b> | <b>315,02</b> | <b>41,81</b> | <b>397,97</b> | <b>52,82</b> |
| 66074 | 183,7 | 42,6 | 1,8 | <b>224,00</b> | <b>29,73</b> | <b>410,03</b> | <b>54,42</b> | <b>525,00</b> | <b>69,68</b> |
| 66075 | 228,7 | 42,6 | 1,8 | <b>278,02</b> | <b>36,90</b> | <b>503,98</b> | <b>66,89</b> | <b>650,98</b> | <b>86,40</b> |
| 66076 | 273,7 | 42,6 | 1,8 | <b>312,98</b> | <b>41,54</b> | <b>609,01</b> | <b>80,83</b> | <b>694,00</b> | <b>92,11</b> |

## Ukrasni top iz dva dijela za ormar s ukrasnim str. - deb. 18 mm / Finishing top from two parts for cabinet with finishing sides - thick. 18 mm

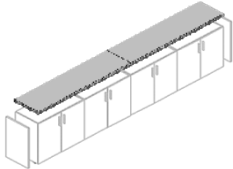

| Art.  | W     | D    | H   | STAND. Kn     | STAND. €     | PLUS Kn       | PLUS €       | GLOSS Kn      | GLOSS €       |
|-------|-------|------|-----|---------------|--------------|---------------|--------------|---------------|---------------|
|       |       |      |     | VPC / PRICE   | VPC / PRICE  | VPC / PRICE   | VPC / PRICE  | VPC / PRICE   | VPC / PRICE   |
| 66077 | 318,7 | 42,6 | 1,8 | <b>499,01</b> | <b>66,23</b> | <b>539,02</b> | <b>71,54</b> | <b>755,03</b> | <b>100,21</b> |
| 66078 | 363,7 | 42,6 | 1,8 | <b>415,00</b> | <b>55,08</b> | <b>639,98</b> | <b>84,94</b> | <b>896,00</b> | <b>118,92</b> |

## Ukrasne stranice za ormar - deb. 18 mm / Finishing sides for cabinet - thick. 18 mm

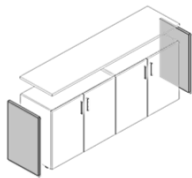

| Art.  | W   | D    | H     | STAND. Kn     | STAND. €     | PLUS Kn       | PLUS €        | GLOSS Kn      | GLOSS €       |
|-------|-----|------|-------|---------------|--------------|---------------|---------------|---------------|---------------|
|       |     |      |       | VPC / PRICE   | VPC / PRICE  | VPC / PRICE   | VPC / PRICE   | VPC / PRICE   | VPC / PRICE   |
| 66081 | 1,8 | 42,6 | 74    | <b>187,01</b> | <b>24,82</b> | <b>360,00</b> | <b>47,78</b>  | <b>399,03</b> | <b>52,96</b>  |
| 66082 | 1,8 | 42,6 | 122   | <b>286,99</b> | <b>38,09</b> | <b>565,01</b> | <b>74,99</b>  | <b>620,01</b> | <b>82,29</b>  |
| 66084 | 1,8 | 42,6 | 195,6 | <b>448,98</b> | <b>59,59</b> | <b>859,01</b> | <b>114,01</b> | <b>944,98</b> | <b>125,42</b> |

## Dodatna polica / Additional shelf

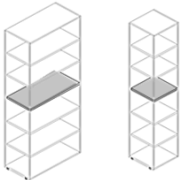

| Art.  | W    | D  | H   | G/A Kn        | G/A €        |
|-------|------|----|-----|---------------|--------------|
|       |      |    |     | VPC / PRICE   | VPC / PRICE  |
| 65099 | 86,4 | 38 | 2,5 | <b>138,03</b> | <b>18,32</b> |
| 65199 | 41,4 | 38 | 2,5 | <b>77,00</b>  | <b>10,22</b> |