

RASPORED SASTAVLJANJA

1 TIPLJE

U predviđene rupe umetnite drvene tiplje.

2 ZAVRŠNA PLOČA

Na gornju stranu ormara pričvrstite završnu ploču.

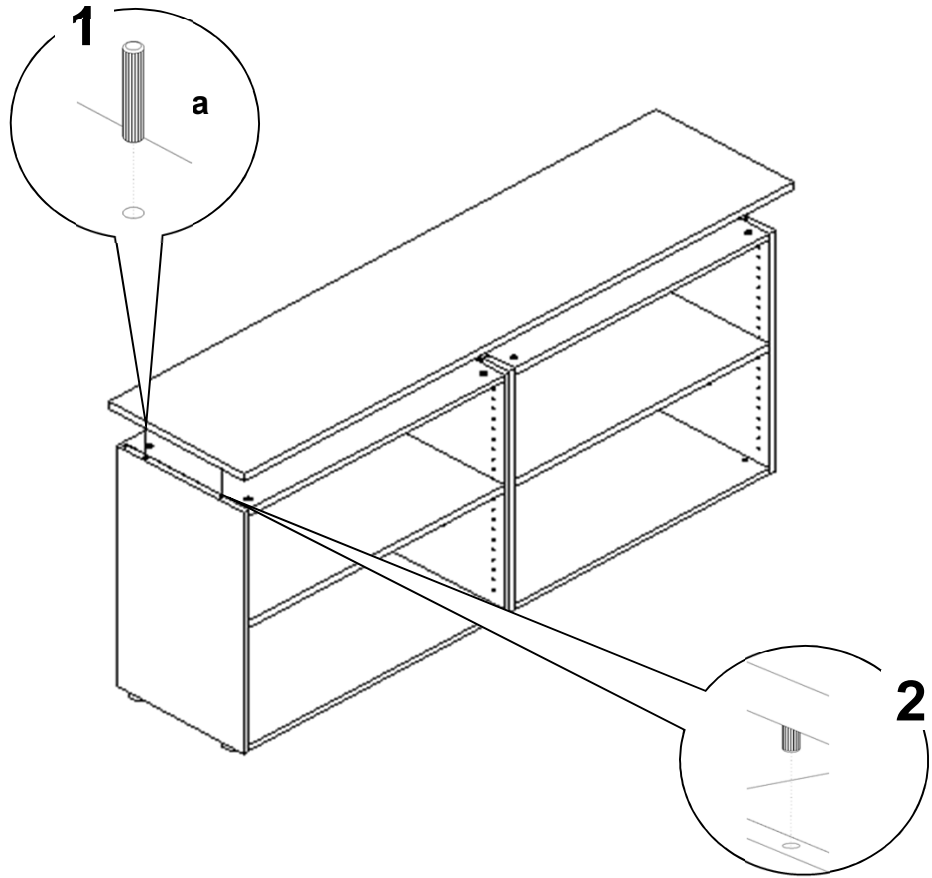

SKICA

OPIS ARTIKLA

BROJ KUTIJA

UKUPNI VOLUMEN

UKUPNA TEŽINA



ZAVRŠNA PLOČA ZA ORMAR S 5 KRILA
dim: 225x45,5x2,5h cm

1 kom

_ m³

_ kg

MONTAŽNI MATERIJAL

ALAT POTREBAN
ZA MONTAŽU

Količina

4 kom

Opis

Tipla drvena

Skica

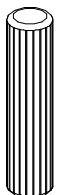

Oznaka

a

Križni odvijač 2

